



## New Conveniences for Microwave Power Measurements

A NUMBER of new thermistor mounts have been developed in the -hp- laboratories for simplifying measurements of microwave power levels. These mounts have all been designed as broadband mounts which require no tuning and have no tuning provision. Any of the mounts can be used with pulse or square-wave modulated power as well as c-w.

The new mounts include both waveguide and coaxial styles. The coaxial mount operates over virtually the entire practical frequency range for coaxial systems—10 megacycles to 10 kilomegacycles. Performance-wise, the VSWR of the mount is less than 1.3 from 50 mc to 5 kmc and less than 1.5 from 10 mc to 10 kmc.

For waveguide use, a series of four mounts has been developed. These are the -hp-487A series, and, collectively, they operate

from 3.95 to 12.4 kilomegacycles. These waveguide mounts also are non-tunable and have a VSWR of less than 1.5.

Since thermistor mounts in themselves serve only as devices for absorbing the microwave power to be measured, they must be used with a power meter such as the -hp- Model 430B Power Meter.\* This meter has a measuring range from 0.01 to 10 milliwatts. The meter itself is essentially independent of frequency and can be used with any of the mounts.

### WAVEGUIDE MOUNTS

In power terms, the VSWR of 1.5 for the waveguide mounts means that less than 0.2 db of the power incident on the mount will be reflected in an otherwise matched system. Although it is possible to achieve lower reflections with tunable mounts such as the -hp-485A tunable mounts, the difference is not great. Where the tunable mounts reflect less than 0.1 db, the new non-tunable mounts reflect less than 0.2 db. Obviously, the non-tunable mounts are suitable for most purposes and, because no adjusting is required, are especially suitable for rapid, production line measurements.

The waveguide sizes and frequency ranges of the four mounts are shown in the accompanying table (next page).

Each waveguide mount consists of a shorted section of waveguide with an uncapsuled thermistor mounted on posts inside the guide. To achieve a broadband

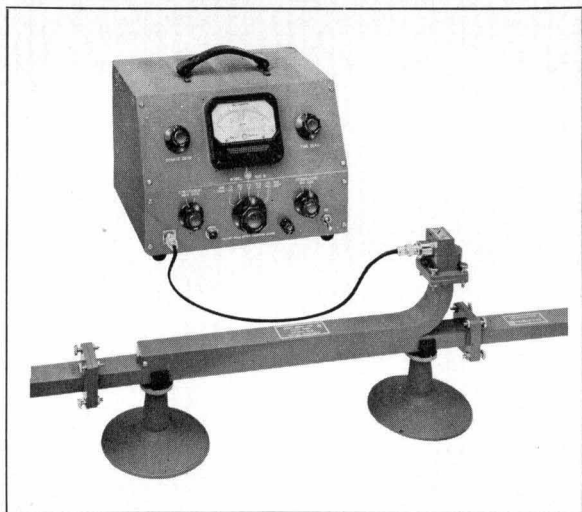

Fig. 1. New -hp- Model 487A broadband thermistor mount used with directional coupler and power meter to monitor power level in waveguide system.

\*A further discussion of the 430B power meter is given in Vol. 2, No. 7-8 of the Hewlett-Packard Journal.

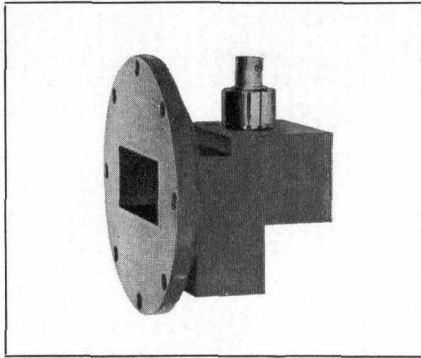

Fig. 2. Model 487A waveguide mount for use with 2" x 1" waveguide from 3.95 to 5.85 kmc.

#### WAVEGUIDE THERMISTOR MOUNTS

-hp- Model	Frequency Range	Waveguide Size (Outer Dimension)
G487A	3.95- 5.85 kmc	2 x 1 in.
J487A	5.85- 8.20	1½ x ¾
H487A	7.05-10.00	1¼ x ⅝
X487A	8.20-12.40	1 x ½

match, shunt capacitive posts and a series capacity slot are arranged to match the thermistor and its mounting structure over the range of a waveguide. An impedance plot representative of the performance of the mounts is illustrated in Fig. 4 for the 8.2 to 12.4 kmc mount. The plot is shown as referred to the plane of the first design element in the mount.

The thermistor element in all of the waveguide mounts is operated at a resistance level of 200 ohms. As in most microwave type thermistors, 200-ohm operation occurs at a power level of approximately 9 milliwatts. This prevents the mounts from being direct-reading on the 10-milliwatt

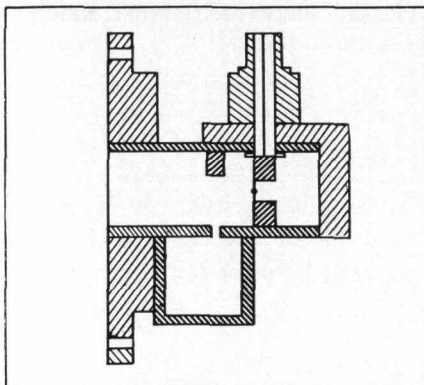

Fig. 3. Simplified cross-sectional drawing of Model 487A waveguide mount.

range of the power meter. The reason for this is that the power meter is a power substitution device, and, in order to measure 10 milliwatts of r-f, the meter must first apply at least 12 milliwatts of low-frequency and d-c power to the thermistor. Since 12 milliwatts would reduce the thermistor to less than a 200-ohm level, the power meter will supply only the 9 milliwatts needed to bias the thermistor to 200 ohms. Because of this, the 487A waveguide mounts are rated for use up to 3 milliwatts—the second highest range of the power meter.

The burn-out value of thermistors is quite high—several hundred milliwatts. At this level, owing to their large temperature coefficient, the thermistors constitute such a poor match for the system that it is unusual in practical use to burn them out. Should burn-out occur, however, the thermistor can be replaced at the -hp- factory or by an experienced technician.

For measuring powers higher than about 3 milliwatts, the mounts should be combined with attenuators or directional couplers. Recommended equipment arrangements are described later.

#### 10 MC-10 KMC COAXIAL MOUNT

The Model 477A coaxial mount uses two uncapsuled thermistors, each operated at 100 ohms. These are arranged to appear in parallel to the r-f line and in series to the power meter. The r-f line thus sees an impedance of 50 ohms, while the power meter sees 200 ohms. This arrangement has been enhanced with a 2-element network to provide a very satisfactory match to a 50-ohm system over the complete 10 mc to 10 kmc range, as indicated by the admittance plot of Fig. 6. The mount can be used to measure power levels up to 10 milliwatts, the highest range of the 430B Power Meter.

The total power necessary to bias a thermistor to 100 ohms is approximately 14 milliwatts. For 200-ohm operation it is about 9 milliwatts.

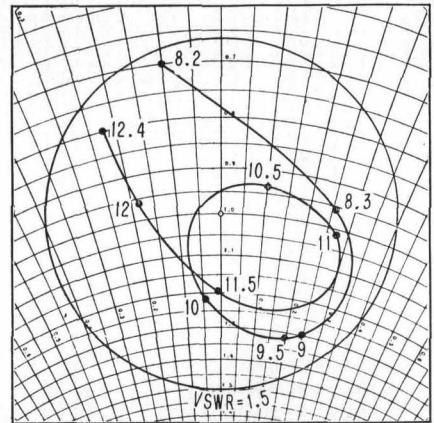

Fig. 4. Typical impedance characteristic of waveguide thermistor mount for 8.2 to 12.4 kmc range (Model X487A).

The 477A mount, since it uses two 100-ohm operated thermistors, requires at least 28 milliwatts of bias but appears to the power meter as 200 ohms. Although the 430B is capable of delivering this amount of bias power, its switching arrangement has been made such that it will not deliver it in the 200-ohm position.

It is therefore necessary to modify slightly the switching arrangement on the 430B to use it with the 477A mount. To simplify this modification, a kit has been arranged such that the 430B can be modified in a short time.

The kit provides for a new current-selecting switch on the 430B. By means of this switch, bias powers well in excess of the nominal 28 milliwatts needed for the 477A mount can be supplied to 200-ohm negative temperature coefficient elements. However, even without this modification the 430B can be used with a wide range of positive and negative coefficient bolometer elements.

The panel of a modified 430B is shown in Fig. 7. The added bias switch is located at the upper right of the panel and is provided with eleven positions. The first position is an "off" position which opens the bias circuits so that low-power bolometer elements can be connected without danger of burn-out. After the element has been connected, the



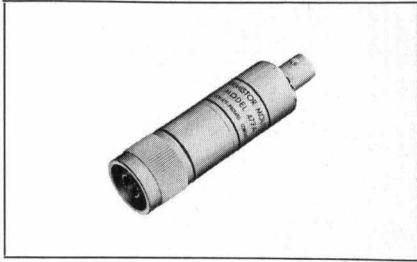

Fig. 5. -hp- Model 477A coaxial thermistor mount for use from 10 mc to 10 kmc.

bias switch can be advanced as necessary to one of the remaining positions. The calibrations for the switch are made on a plate which is color-coded for various types of common bolometer elements. Coarse and fine zeroing controls for the modified 430B are retained, although they have been combined into a dual type control. The controls are effective for each position of the new bias switch and have the same relative effect for each switch position.

Modified 430B's with the kit already installed can be obtained on special order. For a 430B presently in use, the kit can easily be installed by a technician in less than two hours' time. The kit is designed only for the -hp- 430B Power Meter and is not useful with the earlier 430A.

#### MODULATED POWER

Since thermistors have relatively long thermal time constants, they respond in proportion to the duty cycle of pulsed microwave power. Consequently, the new thermistor mounts can be used with the 430B

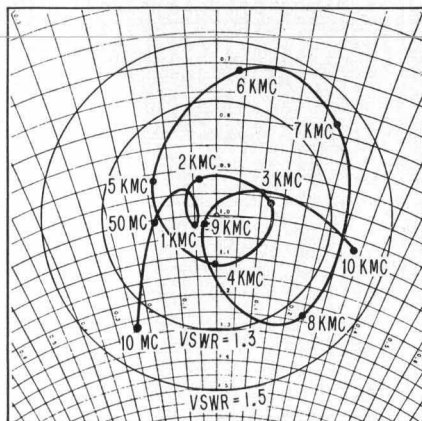

Fig. 6. Typical admittance characteristic of -hp- Model 477A coaxial thermistor mount.

Power Meter to measure pulsed power as well as square- or sine-wave modulated power. The meter reading obtained will indicate the average power received by the mount. If the power level of an individual pulse is required, the meter reading must be multiplied by the reciprocal of the duty cycle of the pulsed power. Readings can be made on pulse repetition frequencies as low as 10 pps.

If the 430B Power Meter is used with short thermal time constant bolometer elements such as barretters, precautions should be taken if the modulation frequency is below about 200 cps. For sine- and square-wave modulated power, the meter reading will tend to increase at low modulating frequencies. On the 10 milliwatt range of the power meter, this increase will tend to occur at modulating frequencies below 200 cps; on the other ranges, the reading will be unaffected down to approximately 100 cps.\*

The basic reason for the increase in reading is that the barretter resistance tends to follow the modulation on the r-f power. This, in turn, causes a modulation of the self-balancing bridge oscillator used in the power meter. This modulation, when applied to the indicating system in the power meter, results in a meter deflection that is the average of the peak-to-peak voltage of the modulation envelope. However, this average voltage is lower than the rms voltage of the modulated waveform. Because of the power substitution operation of the power meter, the lower average voltage results in a meter reading that is higher than it should be. (In effect, the meter subtracts from its full scale value the amount of substitute power remaining in the barretter. Since the measured value of substitute power is low, the actual meter reading will

\*In Model 430A Power Meters and in Model 430B's having serial numbers below 961, these frequencies are 1700 and 850 cps, respectively. In these same instruments some increase in reading may be obtained when using thermistors with sine- and square-wave modulated power at modulating frequencies below 350 cps.



Fig. 7. -hp- Model 430B power meter as modified for use with Model 477A coaxial thermistor mount. New bias current switch is at upper right of panel.

be high.) The limiting condition is that the meter reads about 1 db high when the modulating frequency is much lower than 200 cps (or 100 cps for the lower ranges). This is the maximum error obtained when using barretters with the power meter to measure sine- or square-wave modulated power.

When using pulse-modulated power with barretters, an effect somewhat different from the above is obtained. At pulse frequencies near submultiples of the 10.6 kc bridge oscillator frequency, beats are produced which show on the meter. At modulating frequencies which are exact submultiples of the oscillator frequency, the oscillator may lock in with the modulation frequency with the result that the meter pointer can dip to a low value. This effect is most noticeable on the 0.1 milliwatt range of the power meter. In either case, the effect can be avoided by changing the repetition frequency slightly so that it is not a submultiple of the 10.6 kc power meter oscillator frequency. This solution can be used down to frequencies at least as low as 200 pps.

When the 430B Power Meter is used with a thermistor to measure pulsed power, some beating of the meter pointer may occur. If desired, this can be avoided by changing slightly the pulse frequency. No incidental effects of this nature are obtained when the 430B is used with thermistors to measure sine- or square-wave modulated power at usual modulating frequencies.

## MEASURING HIGHER POWERS

Microwave power measurements usually fall into one of two classes: measuring the power absorbed by the thermistor element when it is used as a flat load for the system; or monitoring the power level in a system without disturbing the power flow. Diagrams at the right illustrate practical methods for such measurements. The power ratings shown in the diagrams are average power ratings. In all cases the set-ups will accommodate much higher pulse powers. The equipments shown in the diagrams are not necessarily the only *-hp-* equipments that can be used for the measurement. Notes under the diagrams indicate possible alternate equipment choices.

-Wm. Gallagher  
and B. P. Hand

### SPECIFICATIONS -hp- MODEL 487A BROADBAND WAVEGUIDE THERMISTOR MOUNTS

Model	Frequency Range (KMC)	Waveguide Size (in.)
G487A	3.95 - 5.85	2 x 1
J487A	5.85 - 8.20	1½ x ¾
H487A	7.05 - 10.00	1¼ x 5/8
X487A	8.20 - 12.40	1 x ½

VSWR: Less than 1.5 entire waveguide frequency range.

MAXIMUM POWER LEVEL: 3 mw.

METER CONNECTOR: Type BNC jack.

THERMISTOR TIME CONSTANT: Approximately 1 second when cooling on an open-circuit.

FLANGES: Mounts are provided with standard cover flanges.

PRICE:

G487A: \$95.00	H487A: \$80.00
J487A: 90.00	X487A: 75.00

### -hp- MODEL 477A COAXIAL THERMISTOR MOUNT

FREQUENCY RANGE: 10 mc to 10 kmc.

VSWR: Less than 1.5 (less than 1.3 from 50 mc to 5 kmc).

POWER RANGE: .01 to 10 mw (with modified 430B Microwave Power Meter; see "Accessories" below).

CONNECTORS: Input - Type N plug  
Output - Type BNC jack

ELEMENT: 200 ohm, negative temperature coefficient.

ACCESSORIES: -hp- 430B-95B Modification Kit. (Adapts -hp- 430B Microwave Power Meter for operation with -hp- 477A as well as other barretters and thermistors.) \$12.50.

-hp- 477A-28A Replacement Thermistor Element Assembly. \$25.00.

PRICE: -hp- Model 477A Coaxial Thermistor Mount \$75.00. (Includes two permanently installed thermistors).

All prices f.o.b. Palo Alto, California.

Data subject to change without notice.

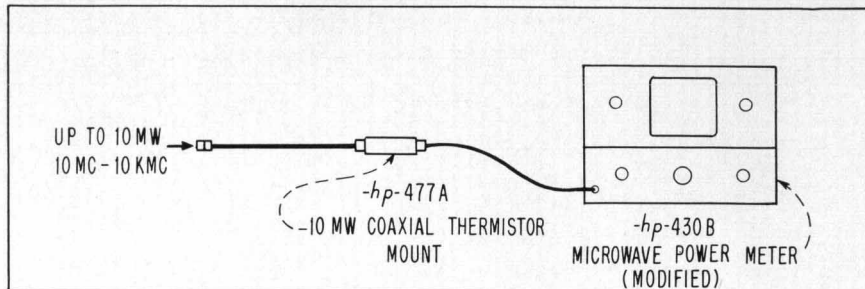

Arrangement for measuring average powers up to 10 milliwatts in coaxial systems.

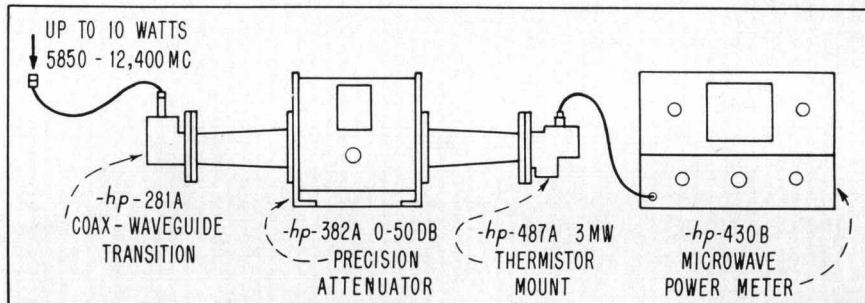

Arrangement for measuring average powers up to 10 watts in coaxial systems. -hp- Model 370 series fixed attenuators, rated at 1 watt, may be useful in some applications in place of 10-watt Model 382A adjustable attenuator.

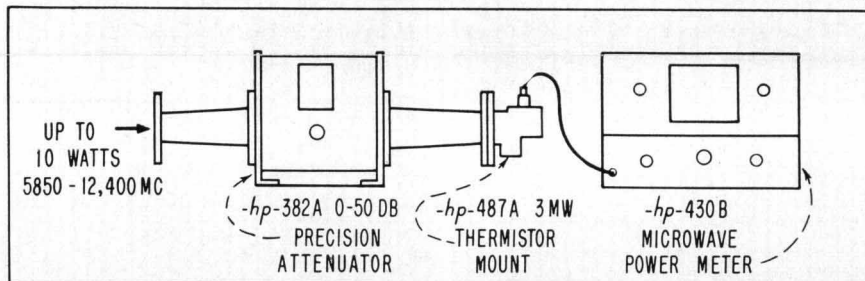

Arrangement for measuring average powers up to 10 watts in waveguide systems. See note above concerning attenuators.

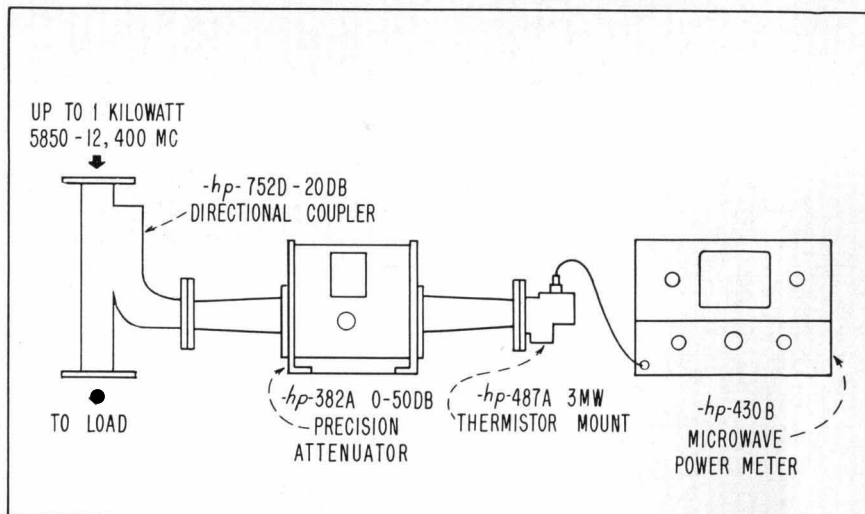

Arrangement for monitoring average powers up to 1 kilowatt in waveguide systems. -hp- Model 750D series cross-guide directional couplers may be used in place of Model 752D. See note above concerning attenuator. For monitoring coaxial systems, -hp- 281A series coax-waveguide transitions can be used at each end of directional coupler.